

**Idea
Ambient unit on cupboard (1GN)
with wheels, overshelf with LED
lights, H=900mm**

ITEM # _____

MODEL # _____

NAME # _____

SIS # _____

AIA # _____

**322044 (F00N1AW00S)**

Ambient Unit on cupboard (1 GN) with wheels and two stainless steel tray sliders, H=900mm

Short Form Specification**Item No.** _____

Compact design, ideal for space saving environments. AISI 304 Foldable tray sliders on long sides. Unit mounted on 125 mm wheels 2 swivel and 2 with brakes. Top provides ample displaying or workspace surface. Sturdy body construction with laminated panelings on 4 sides. 900mm worktop height.

Main Features

- Perfect compact design makes it ideal for space saving environments.
- CB and CE certified by a third party notified body.
- Soft closing doors on operator side.
- Available options with online configurator: colors, tray sliders, overshelves, feet/wheels with desired diameter, height 750mm for kids.
- Top provides ample displaying or workspace surface.
- Optional plinth can be installed to cover the feet or the wheels.
- AISI 304 Tray slider in flush mounted stainless steel is installed on long sides and they can also be folded down to facilitate passage of the units through doorways.
- Ideal for servery lines without an operator.
- Unit mounted on 125 mm wheels 2 swivel and 2 with brakes.
- Food introduced at the correct temperature maintains its core temperature according to Afnor Standards.
- Available dimensions: 1, 2, 3, 4 GN.

Construction

- Top in AISI 304.
- Sturdy construction with laminated panelings on 4 sides.

APPROVAL: _____

Front

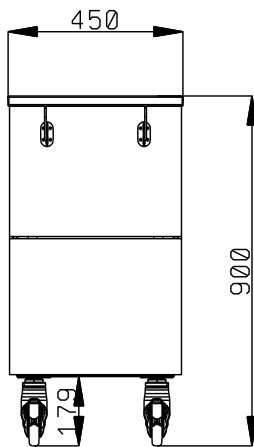

Side

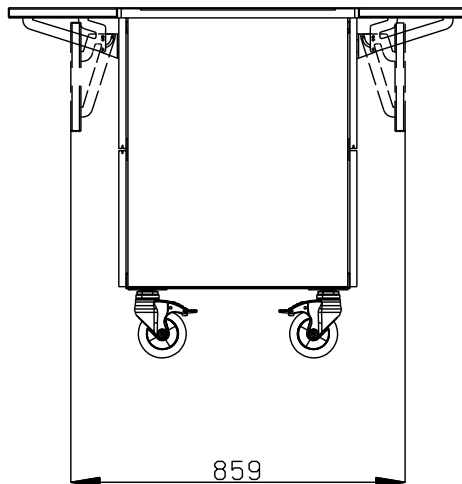

Top

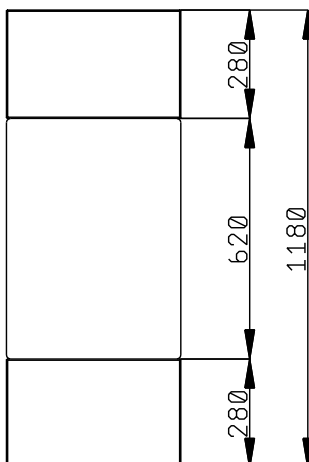

Key Information:

N° of doors:	1
322044 (F00N1AW00S)	
External dimensions, Width:	450 mm
External dimensions, Depth:	1180 mm
External dimensions, Height:	900 mm
Net weight:	48 kg
Shipping height:	1100 mm
Shipping width:	500 mm
Shipping depth:	900 mm
Shipping volume:	0.5 m ³